

*Creative
Banquet
Concepts*



EVENTS

TEXTILES



INDEX

- 1 - 2 Introduction
- 3 - 12 Chair covers
- 13 - 14 Printed covers
- 15 - 22 Cocktail table covers
- 23 - 26 Stage & table skirting
- 27 - 30 Table covers
- 31 - 32 Beer table covers
- 33 - 38 Conference cloths
- 39 - 42 Table cloths
- 43 - 44 Bed covering
- 45 - 46 Caps & Cushion covers
- 47 Trolley covers
- 48 Partition screens
- 49 - 50 Protection covers
- 51 - 54 Fabric colours
- 55 Clips & accessories

Evento Textiles is the producer of customised textile decorations for the hospitality and event industry. With our 15 years of experience we have obtained a very high quality standard in the market.

Thanks to our large stock in dyed fabrics and logistics by air freight, we are able to fulfil the customer's demand for customised textile decorations on a very short delivery term. Most of our European orders are delivered within 1-2 weeks, without the need for custom clearance or duties.

Evento Textiles has their own branch in the Netherlands where all goods are being imported from. This way the customer can enjoy cheaper prices, but without the hassle of customs and/or pre-paying VAT.

For the rest of the world, we ship our goods by air or sea freight directly to the country requested on a C&F (cost & Freight) DDU (Delivery Duty Unpaid) basis. Thanks to our high volumes we are able to negotiate very attractive freight charges, and in most cases even better than when the customer arranges the shipment themselves (therefore on Ex Works).

Our main focus is the customised textile decorations which include perfectly fitted covers for your chairs, tables and other furniture. Besides the products shown in this catalogue we can produce and design anything that you or your customer wish to have covered.

We look forward to a pleasant working relationship with your establishment.



Chair COVERS

Nothing is more exclusive than creating your own chair cover in an affordable way. Evento offers you tailor made chair covers; designed and fitted precisely according to your requirements. Through innovative and outstanding designs, we target to create additional value and a unique atmosphere for your events.



Day & Night Collection



Mystery's with table cloth



Custom Made Stretch Covers

CHAIR Covers

Thanks to the wide range of colours and fabrics, we are able to meet all your demands.

Evento stands out in the market with continuous creation of new designs and supply of various types of fabrics.



Novara back side



Novara front side



Mystery Chair covers



Day & Night Collection

Chair COVERS

models



Talange



Ablis



Ajain



Mystery



Ashley



Avery



Belabie



Fleury



Blamont



Chambery



Sophia



Isa



Chepy



Cuincy



Poisson



Camares



Zoe



Ranville

CHAIR

Covers

models

Chair COVERS



Remilly



Avertin



Chely



Piennes



Novara



Evran



Cayenne



Epain



Grenoble



Lorient



Cergy



Terville



Fontaine



Maurice



Julien



Troyes



Toulon



Valady



Charmont



Vimy



Bourges



Duclair



Cannes



Nancy

CHAIR Covers

Chair COVERS

accessories



Organza Tie
25 x 250 cm



Organza Tie
50 x 250 cm



Plain Tie



Twist Tie



Sash Tie



Sash with Rosettes Tie



Spider Tie



Cowboy Tie



Cassia tie



Orb tie



Chaco tie



Scalper tie



Mirror tie



Castilla tie



Betula tie



Ficus tie



Litchi tie



Mask tie



Fancy tie



Fork tie



Hemlock tie



Celtis tie



Juniper tie



Foxtail tie



Licuri tie



Areca tie



Aspen tie



Valor tie



Sword tie



Star tie



Sassy tie



Web tie



Agonis tie



Arenca tie



Crocodile tie



Hero tie



Rhombus tie



Buxus tie

CHAIR

Covers

Chair COVERS



CHAIR Covers

- Please mark the chair which comes closest to your model and fill in the requested dimensions. Also send us a picture of your chair itself in order to produce a customised cover accordingly
- Select your own design; please check pages 5 to 11 to give your recommendations
- Select the fabric; we have 5 different fabrics with various colours suitable for chair covers and available from stock without any minimum quantity required.
 - Classic – 155 cm width – 100% Polyester, plain woven fabric
 - Jersey – 160 cm width – 100% Polyester, round knitted fabric
 - Heavy Jersey – 160 cm width - 100% Polyester, round knitted fabric
 - Senator – 180 cm width – 100% Polyester, knitted & brushed fabric
 - Stretch – 160 cm width – 90% Micro polyester – 10% Lycra
- Any other fabric request can be handled upon demand
- Please mention the requested quantity in order to provide you with the best possible prices

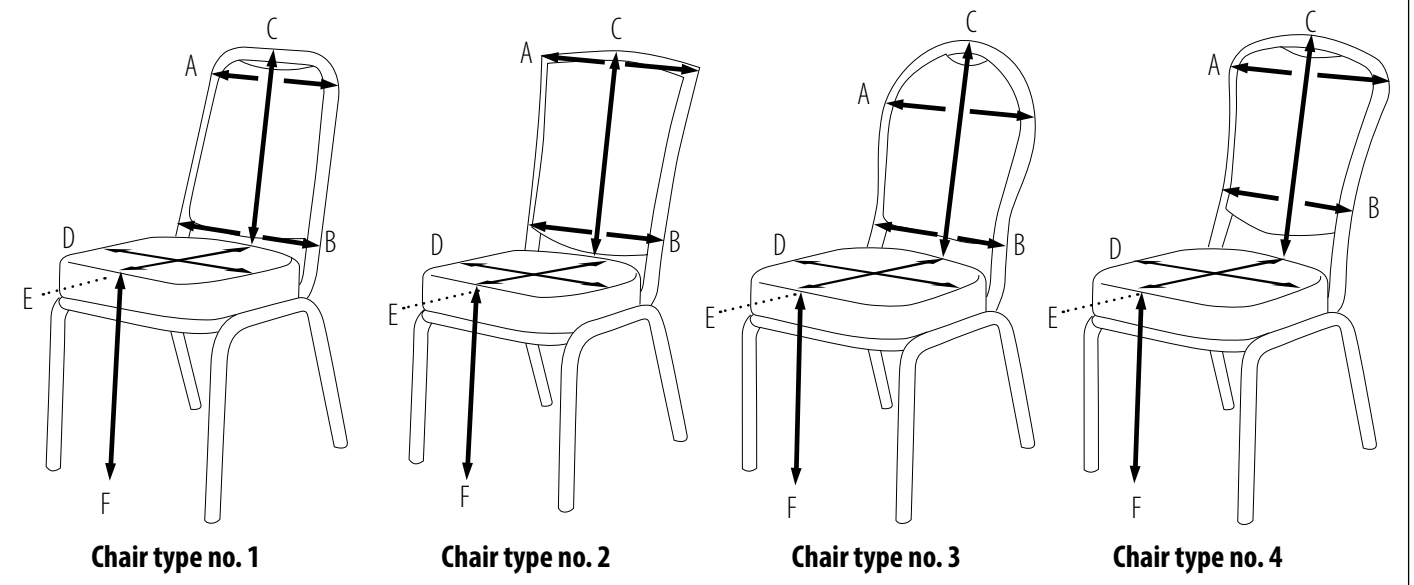

Chair Type no.		
A)	Width of the back rest from top	cm
B)	Width of the back rest from bottom	cm
C)	Height of the back rest	cm
D)	Width of the seating area	cm
E)	Depth of the seating area	cm
F)	Height from seating area to floor	cm

Printed

COVERS

Evento developed a new collection with a large variety of printed designs. This can give your party or corporate event the necessary tools to customise it according to the customer's wishes.



PRINTED

Covers



Cocktail TABLE COVERS

Cocktail table covers are the basic keys for a neat presentation at all sorts of events. Evento offers the best and most stylish presentation and conceptual decoration of cocktail tables.

We offer stretch covers to obtain a modern futuristic look as well as other classic cocktail table cover options for a luxury look. Our stretch covers are offered with or without prints.



Orange Party



Spandex Gold



White & Red Cocktail

COCKTAIL TABLE

Covers

As there are various types of cocktail tables, we provide tailor made covers that would enable perfect fit and the neat look for your events as well as standard covers that fit any type of cocktail table.

Evento provides a wide range of colours, fabric types and printing options to meet our clients' specific decoration requirements.



Spirit with LED



Colour Variety



White & Red Event



Colour Variety

Cocktail models

TABLE COVERS



Mini Spirit
for 75 cm height table



Spirit
Basic - Viper - Passion



Spirit
Beer Print



Spirit
Zebra Print



Spirit
Wicked



Spirit
Wrinkle



Spirit
Cone



Spirit
Streak



Spirit
Tiger Print



Spirit
Camouflage Print



Spirit
Carnival Print



Spirit
Dutch Flag



Spirit
Scotty



Spirit
Galaxy



Spirit
Swirl



Spirit
Yoda



Spirit
German Flag



Spirit
Spandex Silver



Spirit
Spandex Gold



Spirit
Tube



Spirit
Flare



Spirit
Wings



Wave



Prato

COCKTAIL TABLE

Covers models

Cocktail TABLE COVERS



PRODUCT MANUAL

COCKTAIL TABLE

Covers

- Please mark the cocktail table which comes closest to your model and fill in the requested dimensions. Also send us a picture of your cocktail table itself in order to produce a customised cover accordingly.
- Select the model:
 - Spirit is a standard Stretch model suitable for cocktail tables with a diameter of 85 cm which is divided into 4 sub models; Viper (with scissor legs and 2 bars on the side), Basic (a middle bar with 4 feet on the bottom), Passion (with standard scissor legs) and Sentez (round bottom).
 - Como is a customized model that is produced precisely according to the table's top size. Como has no pleat and is suitable for any type of cocktail table.
 - Modena is a standard model suitable for any type of cocktail table. We provide our model Modena in 2 sizes; Small (60-80 cm table tops) and Large (85-100 cm table tops).
 - Roma is a standard model suitable for any type of cocktail table with 4 feet. We provide our model Roma in 2 sizes; Small (60-80 cm table tops) and Large (85-100 cm table tops).
 - Palermo is a standard model suitable for any type of cocktail table and is finished on 300 x 300 cm with a decorative tie.
 - Napoli is a customised model that is produced precisely according to the table's top size. Napoli has a Plisse pleat for a luxury fall and suitable for any type of cocktail table.
 - Verona is a customised model that is produced precisely according to the table's top size. Verona has a Box pleat for a luxury fall and suitable for any type of cocktail table.
- Select the fabric; we have 5 different fabrics with various colours suitable for cocktail table covers and available from stock without any minimum quantity required.
 - Classic – 155 cm width – 100% Polyester, plain woven fabric
 - Jersey – 160 cm width – 100% Polyester, round knitted fabric
 - Heavy Jersey – 160 cm width - 100% Polyester, round knitted fabric
 - Senator – 180 cm width – 100% Polyester, knitted & brushed fabric
 - Stretch – 160 cm width – 90% Micro polyester – 10% Lycra
- Any other fabric request can be handled upon demand
- Please mention the requested quantity in order to provide you with the best possible prices



Como
customized to table top



Modena
Universal, Large & Small



Roma
Universal, Large & Small

Table type no. 1
Spirit Basic

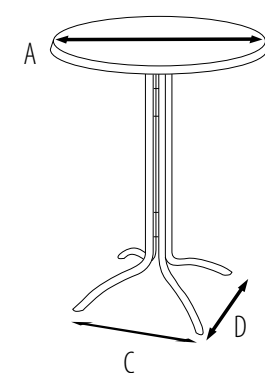

Table type no. 2
Spirit Sentez

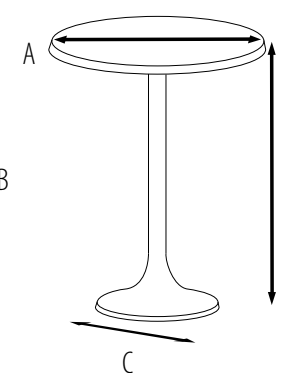

Table type no. 3
Spirit Viper

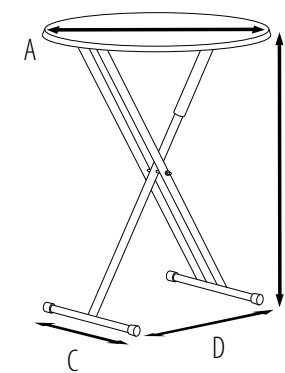
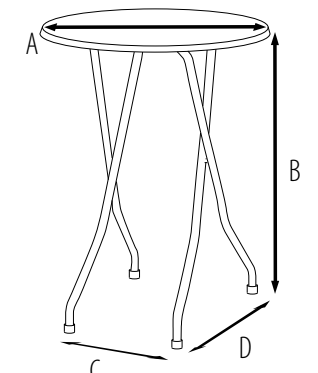

Table type no. 4
Spirit Passion



Palermo
universal



Napoli
customized to table top,
with Plisse pleat



Verona
customized to table top,
with Box pleat

Table Type no.

A)	Diameter of the table top	cm
B)	Height of the table	cm
C)	Width / Diameter of the feet	cm
D)	Depth of the feet	cm

Cocktail TABLE COVERS

accessories



with Print



Spider



Cowboy



Hour glass



Pure



Cage



Butterfly



Halloween



Gothic



Jetty



Tootsy



Spector

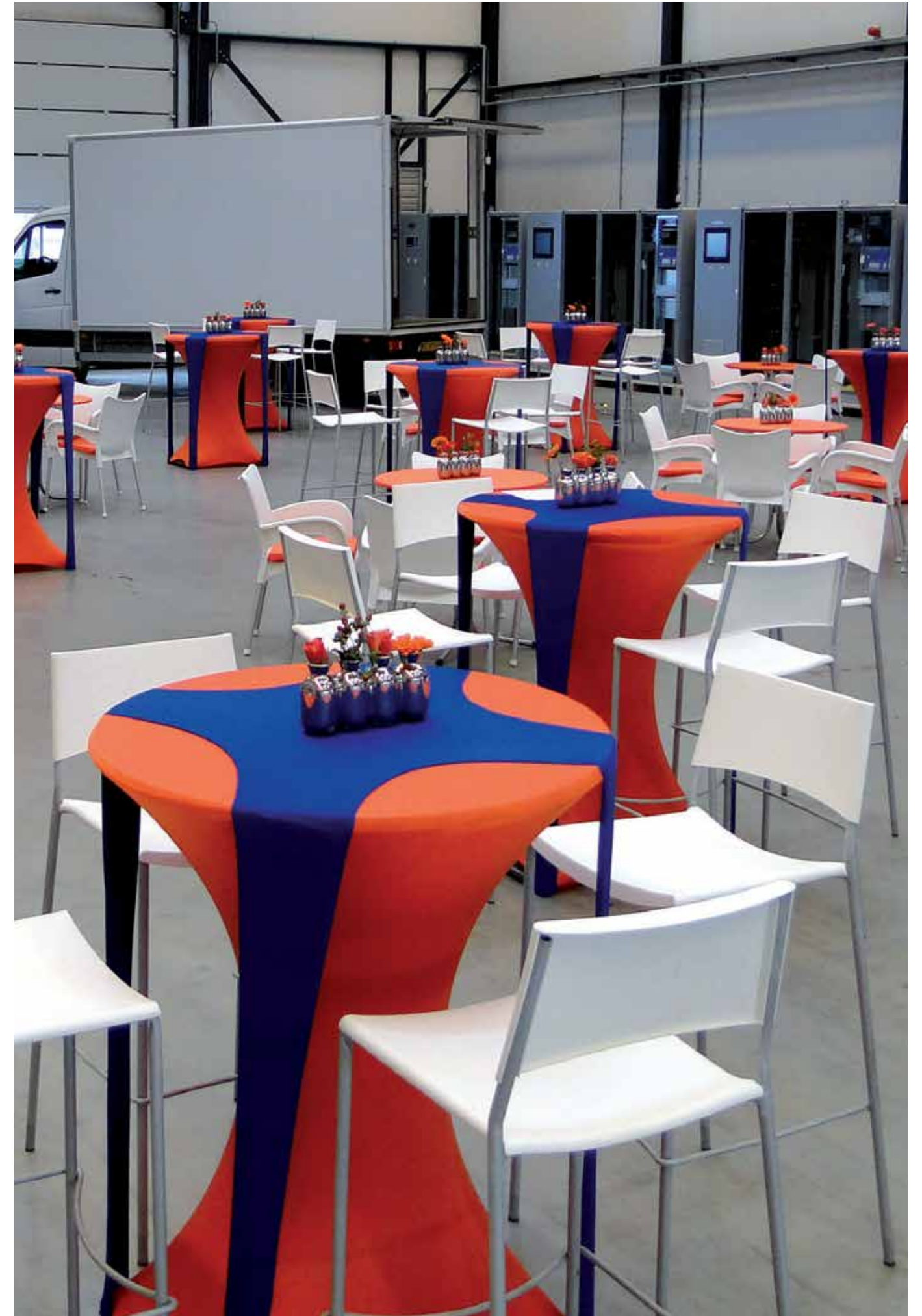

Stage &

TABLE SKIRTING

We offer you the best options for dressing up your tables to get an elegant style and effective functioning for your events. Our stage and table skirtings are offered in 5 different pleat types; Box pleat, Diamond, Butterfly, Accordion, Plisse and without pleat, all produced by automatic pleating machines. We also offer a Dual Height Skirting. All pleat types are available in any size and dimension. Our automated system guarantees a precise and neat look thus a professional image.

Evento also provides a wide range of colours and fabric types to meet our client's specific decoration requirements.



Dual Height Skirting



Skirting without Pleat

STAGE & TABLE

Skirting



Skirting Accordion



Wood Print Skirting



Stage Skirting

Stage &

TABLE SKIRTING



The Dual Height Skirting as seen here on the left side, can be used on 2 different heights. The front skirting has a 250% boxpleat, but can be produced according to any requested pleating style and is fixed on 1 height. The back skirting is produced without a pleat. Once closed (see picture A) it is on the same height as the front skirting (with the Velcro attachment on the back side), once folded open (see picture B) it is on a longer height as requested by the client.

Dual Height Boxpleat 250%



Diamond 250%



Butterfly 300%



Plisse 180%



Boxpleat 250%



Accordion 200%



No Pleat



Valance without rosettes



Valance with rosettes



Table Cover Plisse (top cloth & Skirting stitched together)

Skirting

- Please check below mentioned drawing for calculating the exact size of your custom-made skirting
- Table height minus 1-2 cm is skirting height, in order for the skirting not to touch the floor
- Select the pleating style; every pleat has a different look as well as a different fabric usage, therefore different in price. Thanks to our automatic pleating machines we can make any percentage of pleat and sizes based upon the client's request.
 - Boxpleat; on 250% is a double pleat on a width of 8 cm.
 - Diamond; on 250% is a box pleat with a little trim just below the pleat.
 - Butterfly; on 300% is a box pleat in the middle with an accordion pleat on each side.
 - Accordion; on 200% is a single pleat on a width of 8 cm.
 - Plisse; on 180% is a single pleat on a width of 2 cm.
- Select the fabric; we have 4 different fabrics with various colours suitable for skirting and available from stock without any minimum quantity required.
 - Classic – 155 cm width – 100% Polyester, plain woven fabric
 - Jersey – 160 cm width – 100% Polyester, round knitted fabric
 - Heavy Jersey – 160 cm width - 100% Polyester, round knitted fabric
 - Senator – 180 cm width – 100% Polyester, knitted & brushed fabric
- Any other fabric request can be handled upon demand
- Please mention the requested quantity in order to provide you with the best possible prices

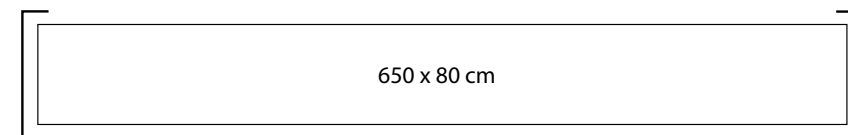

$$650 + (80 \times 2) + (10 \times 2) = 830 \text{ cm}$$

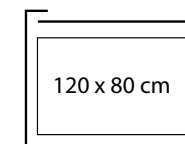

$$(120 \times 2) + (80 \times 2) + 10 = 410 \text{ cm}$$

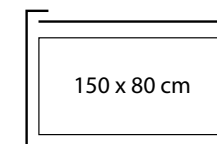

$$(150 \times 2) + (80 \times 2) + 10 = 470 \text{ cm}$$

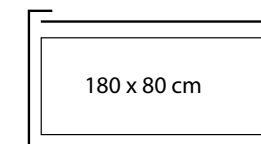

$$(180 \times 2) + (80 \times 2) + 10 = 530 \text{ cm}$$

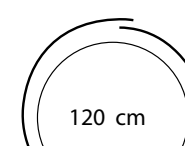

$$120 \times 3.14 + 10 = 390 \text{ cm}$$

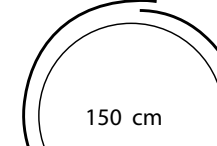

$$150 \times 3.14 + 10 = 480 \text{ cm}$$

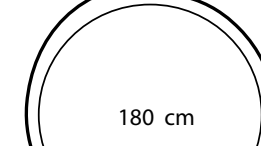

$$180 \times 3.14 + 10 = 575 \text{ cm}$$

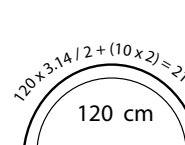

$$120 \times 3.14 / 2 + (10 \times 2) = 210 \text{ cm}$$

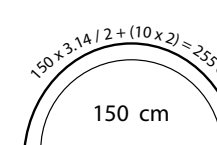

$$150 \times 3.14 / 2 + (10 \times 2) = 255 \text{ cm}$$

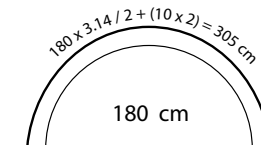

$$180 \times 3.14 / 2 + (10 \times 2) = 305 \text{ cm}$$

Table

COVERS

Our table cover models offers a perfect way to dress up tables in an open area or in a meeting room. When a pleated cover is not preferred, our table covers are the best alternative. Evento can create several designs such as a stretch cover with the Cowboy cover on top, Silver Gold and printed or plain covers with corner splits. Various printing and embroidery options are available to personalise our client's events.

Evento provides a wide range of colours, fabric types and printing options to meet our client's specific decoration requirements.



Stretch Table Cover



Table Cover with Plain Tie

TABLE

Covers



Day & Night



Day & Night



Fitted Stretch Covers

Table models

COVERS



Paris
Box Model



Paris
with Corner Pleats



Paris
with Corner Splits



Plisse
Table Cover



Boxpleat
Table Cover



Carna
Table Cover



Lyon
Table Cover



Lyon
Table Cover with Cowboy



Wave
Table Cover

PRODUCT MANUAL

TABLE

Covers

Select the model:

- Table cover Paris is a fixed and fitted table cover divided into 3 types:
 - Paris Box Model: plain without any pleats or splits
 - Paris with Corner Pleats: reversed box pleat on the corners
 - Paris with Corner Splits: splits on the corners with an extra flap stitched under each split in order to hide to table legs.

- Table Cover Plisse; suitable in all fabrics mentioned here below with a 180% plisse pleat stitched to the side

- Table Cover Boxpleat; suitable in all fabrics mentioned here below with a 250% boxpleat stitched to the side

- Table Cover Carna; Stretch top with a Senator 160% Shirred stitched to the side

Table height minus 1-2 cm is cover height, in order for the cover not to touch the floor

- Table cover Lyon is a fitted table cover from Stretch which can be produced for any kind of table. In order to produce this cover we would need the table sizes (length x width x height) as well as the distance between the feet (length x width). For a visual please check below drawing.

- Cowboy is an extra cover that can be fitted on top of our Table Cover Lyon to give some extra dimension to your design.

- Table Cover Wave is a fitted table cover from Stretch with a pleat fall on the bottom, which can be produced for any kind of table.

Select the fabric;

- we have 6 different fabrics with various colours suitable for table covers and available from stock without any minimum quantity required.

- Classic – 155 cm width – 100% Polyester, plain woven fabric
- Jersey – 160 cm width – 100% Polyester, round knitted fabric
- Heavy Jersey – 160 cm width - 100% Polyester, round knitted fabric
- Senator Single Sided – 180 cm width – 100% Polyester, knitted & brushed fabric
- Senator Double Sided – 180 cm width – 100% Polyester, knitted & brushed fabric
- Stretch – 160 cm width – 90% Micro polyester – 10% Lycra

- Any other fabric request can be handled upon demand

- Please mention the requested sizes and quantity in order to provide you with the best possible prices

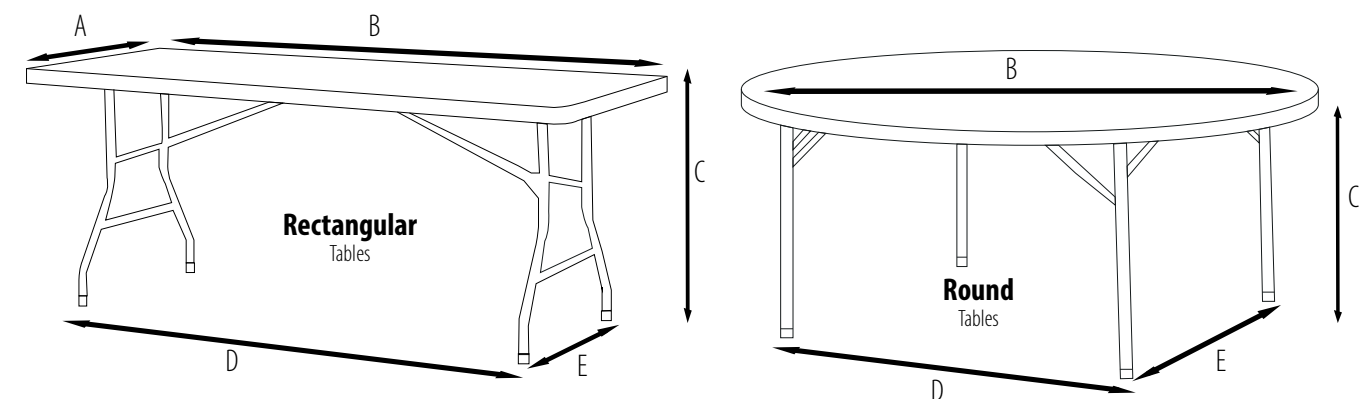

Table Type no.

A)	Width of the table top	cm
B)	Length / Diameter of the table top	cm
C)	Height of the table	cm
D)	Distance between the length feet	cm
E)	Distance between the width feet	cm

Beer TABLE COVERS

The perfect way to decorate or to cover up the beer tables! Models are available in a wide range of colours and fabric types; as well as different designs.

Our standard model is 220 x 50 x 70 cm (table) and 220 x 25 x 50 cm (bench), but any size can be produced thanks to our custom made production.

BEER TABLE

Covers



*Belgian setup
in Stretch*



*Combine
Colours*



*Dutch setup
in Stretch*



*Set in
Classic*



*German setup
in Stretch*

Conference CLOTHS

Conference cloths and covers are the most demonstrative detail to complete a corporate event. Evento Textiles offers a wide range of colours, fabrics, designs as well as customised production options so that any conceptual requirement of our clients is met. We offer various printing and embroidery options to be able to personalise our client's events.



Conference Skirting



Stretch Style



Monaco

CONFERENCE

Cloths



Washington



London



Day & Night



Stretch Classroom Type

Conference CLOTHS

CLOTHS



Stretch cover Lyon

Stretched to bottom feet on the back side



Conference cover Monaco

Folded by hand to backside and pinned to table



Conference cloth Washington

Natural 15 cm drop on backside, no fixing necessary



Conference cover London

Fitted cover with a 15 cm drop on back side, no fixing necessary



models

CONFERENCE

Cloths

Evento offers many possibilities of personalising your cloths and covers. For our Senator Single Sided and Double Sided we offer embroidery options. Depending on the design of the logo we can embroider up to 100 cm in length or height. For our other fabrics we have embroidery and transfer applications available in any size or colour as required by the client. All these options are without any minimum quantity.

Please find below some of our finished projects.



- Table height minus 1-2 cm is cloth height, in order for the cloth not to touch the floor
- Select the model:
 - Stretch cover Lyon is a fitted conference table cover from Stretch which can be produced for any kind of table. We provide our clients with the option for a 3 sided covered model or completely closed on all 4 sides.
 - Conference cover Monaco is a fixed and fitted conference cover with splits on the 2 front corners and extra flaps stitched under each split in order to hide the table legs. The cover falls down to floor level from 3 sides and the backside (seating area) has a drop of 15 cm along with 15 cm side panels so that seat comfort is guaranteed and the back table legs are not seen.
 - Conference cloth Washington is a rectangular piece of cloth with rounded corners on the front side to prevent floor touch and falls down to floor level from 3 sides of the table. The backside (seating area) has a drop of 15 cm so that seat comfort is guaranteed.
 - Conference cover London is a fixed and fitted conference cover with splits on the 2 front corners and extra flaps stitched under each split in order to hide the table legs. The cover falls down to floor level from 3 sides and the backside (seating area) has a drop of 15 cm so that seat comfort is guaranteed.
- Select the fabric; we have 6 different fabrics with various colours suitable for cocktail table covers and available from stock without any minimum quantity required.
 - Classic – 155 cm width – 100% Polyester, plain woven fabric
 - Jersey – 160 cm width – 100% Polyester, round knitted fabric
 - Heavy Jersey – 160 cm width - 100% Polyester, round knitted fabric
 - Senator Single Sided – 180 cm width – 100% Polyester, knitted & brushed fabric
 - Senator Double Sided – 180 cm width – 100% Polyester, knitted & brushed fabric
 - Stretch – 160 cm width – 90% Micro polyester – 10% Lycra
- Any other fabric request can be handled upon demand
- Please mention the requested sizes quantity in order to provide you with the best possible prices

Conference Cover Monaco

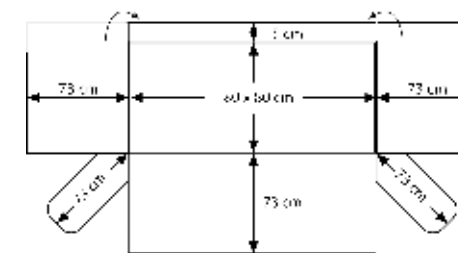

Conference Cloth Washington

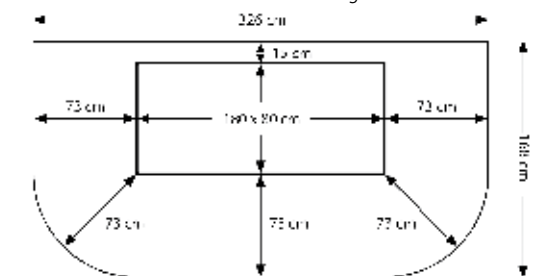

Conference Cover London (rectangular)

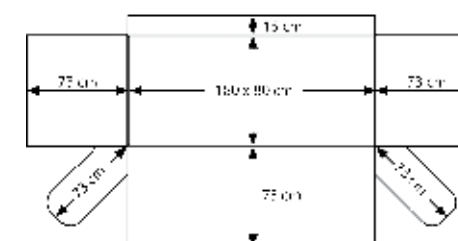

Conference Cover London (half round)

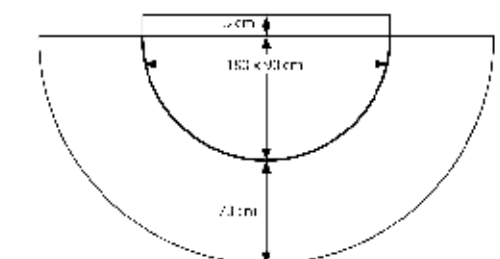

Table

CLOTHS

Evento's placemats are available in many different varieties thanks to our custom-made production. We produce place mats with borders in matching colours, with cutlery pockets, diagonal finishing, to suit the client's requirements.

Evento also provides a wide range of colours and fabric types to meet our client's specific decoration requirements.



Classic with border



Prestige with pockets

PLACEMATS



Classic plain

RUNNERS

CLOTHS

Table

Evento's table runners are available in many different varieties thanks to our custom-made production. We produce runners with borders in matching colours, with cutlery pockets, diagonal finishing, however the client prefers.

Evento also provides a wide range of colours and fabric types to meet our client's specific decoration requirements.



Prestige with pockets



Classic with border



Classic plain



Classic plain

Table

CLOTHS

Event's table cloths create a most decorative atmosphere for your restaurant or event. With our matching underlays and overlays in many different jacquard designs as well as plain options we give your dining table a glorious look! We offer you the softness and iron free option in 100% Polyester as well as stiffness and luxury touch of Poly cotton fibres.



Jacquard yarn dyed



Embroidered Organza

UNDERLAYS



Royal Plain White

OVERLAYS

TABLE

Cloths

To create a luxurious table finish we can offer you many variations in printed and embroidered Organza, which is the perfect overlay to be used in weddings or events.



Heavy Jersey Purple



Jacquard yarn dyed



Royal Collection



Under & Overlay

Bed COVERING

Evento's Bed covering include Boxspring covers, Bed runners, Bed Covers and decorative pillow covers. All these products can be produced with or without decorative frame in a matching colour. The most common fabric to be used for these covers is Senator Double Sided because of its stiff and thick appearance.



Corner pleat of boxspring cover



Decorative pillow covers

BED COVERING

Evento also provides a wide range of colours and fabric types to meet our client's specific decoration requirements.



Middle pleat of boxspring cover

Covering

models



Boxspring cover with runner & decorative pillow covers



Bed cover with decorative pillow covers

Caps &

CUSHION COVERS

The perfect solution for a decorative environment and very useful for events where corporate or matching colours need to be used. Evento produces artificial leather and/or stretch cushion covers that can easily be stapled to your chair or other type of furniture to create a different atmosphere.



Cushion Covers



Dury



Artificial Leather

CAPS & CUSHION

Covers

If necessary we can also supply the foam and wooden parts for the cover to make it a complete cushion.

Evento also provides a wide range of colours and fabric types to meet our client's specific decoration requirements.



Cher



Cher

models

models



Caps



Lounge Covers

Trolley COVERS

The perfect solution to cover up the cold appearance of the restaurant & room service trolleys.

Evento Textiles offers a wide range of colours, fabrics, designs as well as customised production options so that any conceptual requirement of our clients is met. We offer various printing and embroidery options.



Merida



Montoro



Cordoba

PARTITION

Screens

Evento's Partitions are a perfect solution to divide a room into half or to cover up a certain area. Our standard model has a height of 200 cm with a length of 100 cm, but according to the clients request we can customise them accordingly.

Another option would be the Skirting Trolley cover. This gives you the flexibility of multi-functional usage. Both models can be produced in a wide range of colours and fabric types. Printing and embroidery options are available upon demand.



Partition screen in Classic

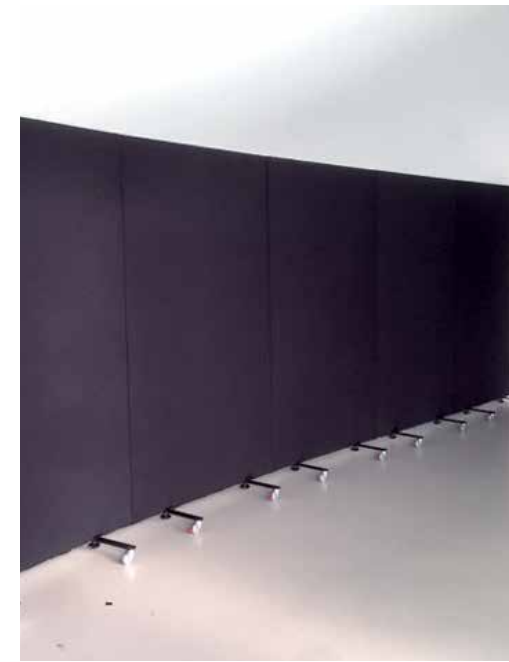

Partition screen in Classic



Partition screen Stretch



Partition screen with loops



Partition screen with tunnel

models

models

Protection

COVERS

Evento's fabric Moulton and PVC table protector are the perfect solution to create an anti-slip environment for your table cloths and to sound proof the table.

Our fabric Moulton covers are produced custom-made according to the exact table top size with an elastic fitting on the bottom. This way the cover is very easy in usage and laundry. Thanks to the large width of 220 cm we don't need to make any mid seam for larger sized tables.



Moulton Cover



PVC table protector

moultens



Covers for wooden tables

PROTECTION

Covers

Our PVC table protector is used for the top side of your table and can be supplied on cut size customised to your table size or ready on roll (width 140 cm).

Evento's table protectors produced from "Heavy Moulton" are designed and produced for storing and transporting your furniture. This way your furniture will not get damaged that quickly and it covers the item for dirt or liquids. There are no limitations to the type of product that can be covered thanks to our custom-made production.



Covers for storage boxes



Covers for table tops



Covers for furniture



Covers for chairs

Fabric COLOURS

Stretch

* 90% PES - 10% Lycra
 * 160 cm wide
 * 200 gram/m²



A specific Pantone Colour can be dyed upon request and there would be a minimum order quantity and dyeing surcharge.

Quotes can be provided upon request.

FABRIC

Colours

Jersey

* 100% PES
 * 160 cm wide
 * 140 gram/m²

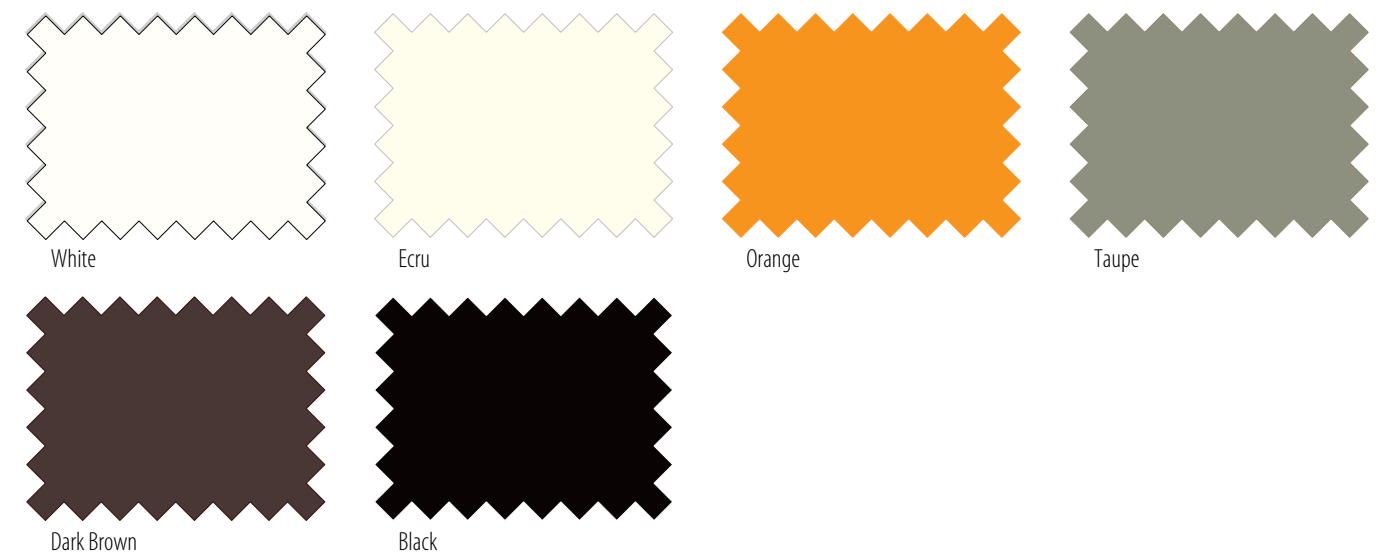

Heavy Jersey

* 100% PES
 * 160 cm wide
 * 225 gram/m²

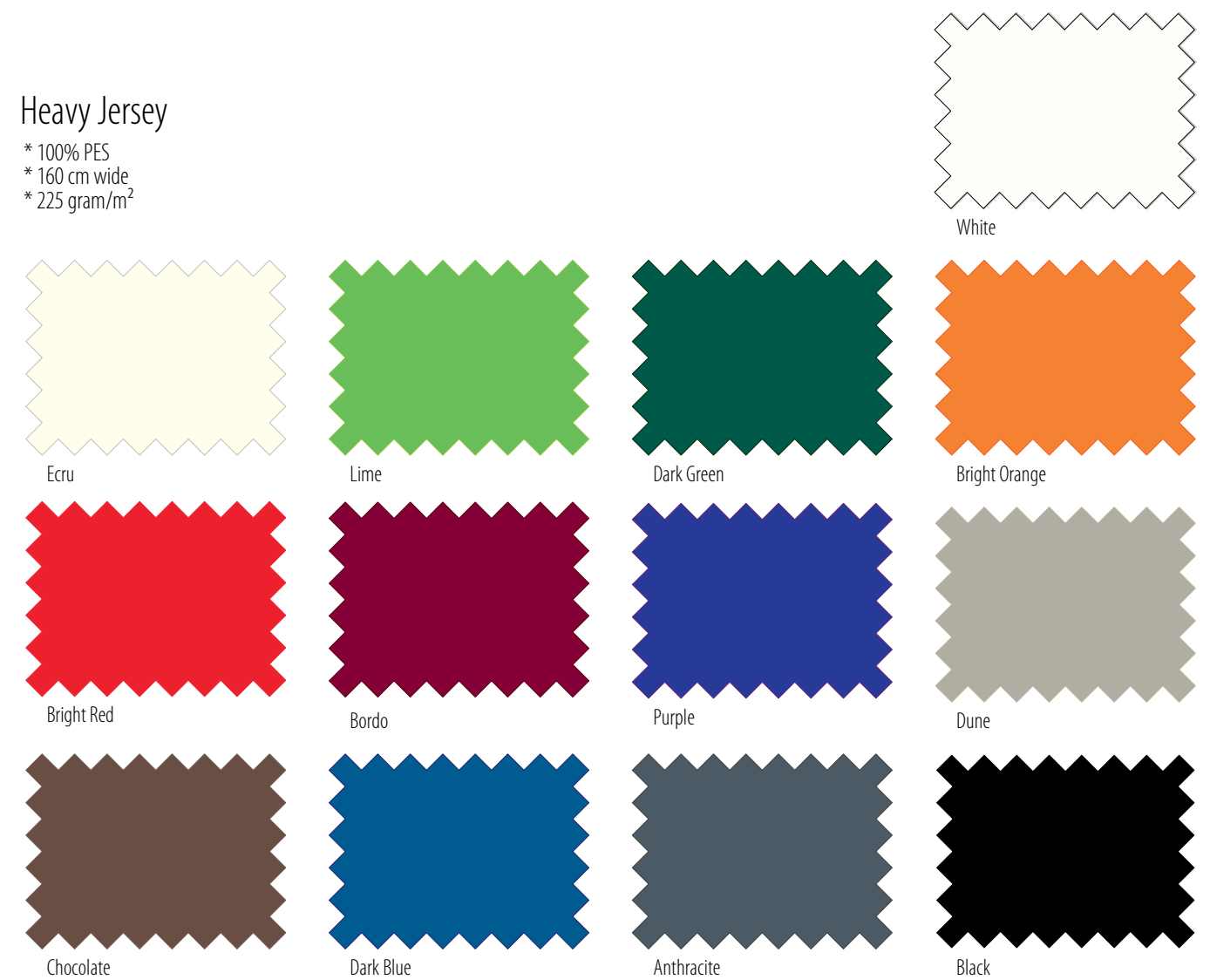

A specific Pantone Colour can be dyed upon request and there would be a minimum order quantity and dyeing surcharge.

Quotes can be provided upon request.

Fabric COLOURS

Classic

* 100% PES
* 156 cm wide
* 175 gram/m²

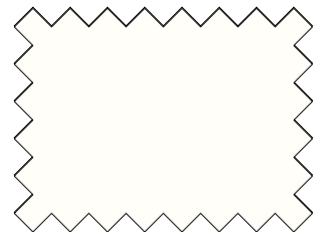

White

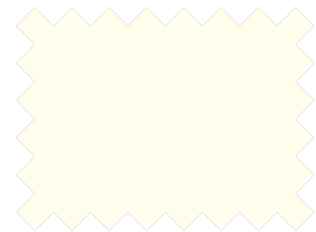

Ecreu



Cream



Lime



Granate



Red



Bordo



Dune



Rust Brown



Dark Brown



Marine



Dark Blue



Anthracite



Black

FABRIC

Colours

Senator

* 100% PES
* 180 cm wide
* 200 gram/m²

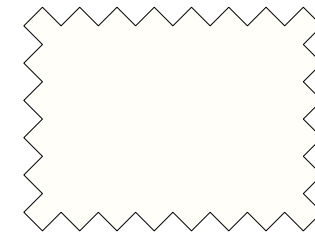

White

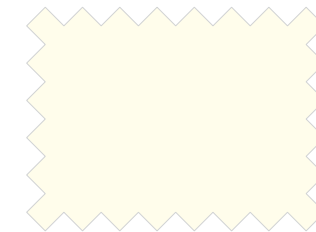

Ivory



Ecreu



Sand



Gold



Ruby



Granate

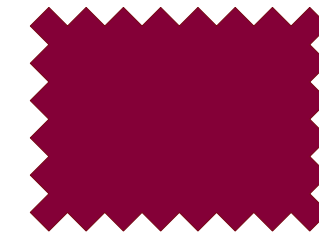

Burgundy



Purple



Marine



Dark Green



Chocolate



Dark Brown



Anthracite



Black

A specific Pantone Colour can be dyed upon request and there would be a minimum order quantity and dyeing surcharge.

Quotes can be provided upon request.

A specific Pantone Colour can be dyed upon request and there would be a minimum order quantity and dyeing surcharge.

Quotes can be provided upon request.

Clips &

ACCESSORIES

Evento offers any kind of table clip, matching your requested table thickness. The clips are easy to use because of the Velcro attachment



1A 15 - 20 mm



1B 15 - 25 mm



1C 15 - 20 mm



1D 21 - 26 mm



1I 15 - 30 mm



1J 25 - 50 mm



3A variabel



3B variabel



3C variabel



4A valance clip



Skirting hanger 4-6 mtr.



Skirting hanger 1-3 mtr.



Self cleaving Velcro Black & White



Self cleaving Velcro Pads



Skirting Trolley with additional product covers (non-woven)





EVENTO

TEXTILES